

Type:

Model:

CHURCHILL Wildlife Safe Hardscape

ORDERING CODE:
490080

SPECIFICATIONS

HOUSING:
Cast brass.

FINISH:
Weathered brass. Custom powder coated colors available.

LENS:
Clear glass.

SOCKET/LAMP HOLDER:
Two fixed ceramic bi-pin sockets accept bi-pin lamps with G4 or GY6.35 bases.

LAMP TYPE:
12V bi-pin. LED recommended. Halogen 30W maximum or 6W LED maximum.

MOUNTING:
Brass mounting plates facilitate mounting under a hardscape cap or flush to a wall.

WIRING:
Pre-wired with 5' pigtail of 18/2 cable.

WARRANTY:
Lifetime.



DIMENSIONS:

Under Cap Mount

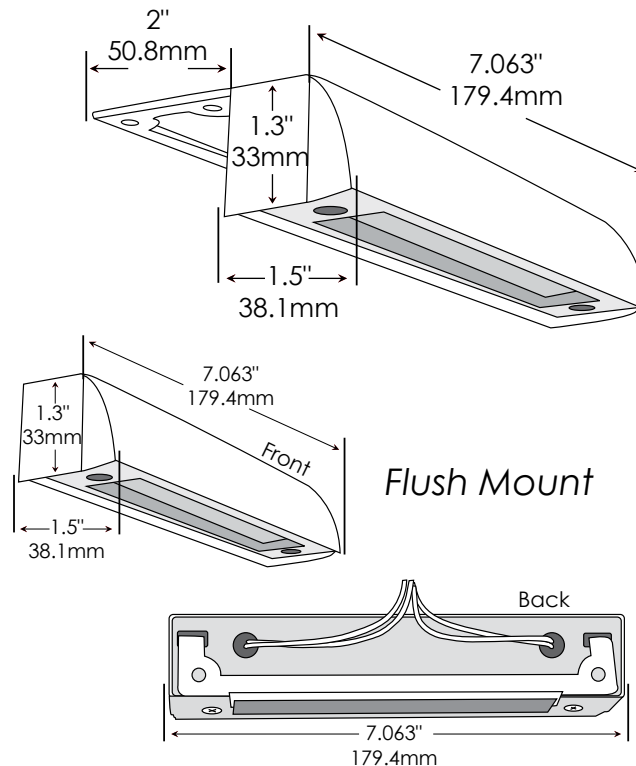

LED LAMP SPECIFICATIONS

LAMP TYPE:

Two 12V Dauer bi-pins with 5-year warranty, dimmable, and suitable for enclosed luminaires.

COLOR TEMPERATURES:

Wildlife-approved, amber and red.

These fixtures are only deemed wildlife approved if they utilize a wildlife-approved amber or red bulb as per the chart below.



FIXTURE ORDERING INFORMATION

To order a lamped fixture with mounting options, select the appropriate choice from each column as in the following example:

EXAMPLE: 490080-487123-WL

FIXTURE	LAMP				
	ORDER NO.	COLOR	DESCRIPTION	WATTAGE	NANOMETER RANGE
490080	487123-WL	Amber-WL	Encap. Bi-pin G4	4w	585-595
	487120-WL	Red-WL	Bi-pin G4	3w	610-645

