



## PRODUCT DESCRIPTION

2' x 2' | 2' x 4' | LED Troffer light | Wattage Selectable  
CCT Selectable | 130lm/W | 0-10V Dimming | Sensor Base

## FEATURES & SPECIFICATIONS



### CONSTRUCTION

- Constructed of one-piece ribbed unitized housing and corners that interlock, preventing damage to luminaire. All sides and corners are turned in and hemmed, removing sharp edges for safe handling & installation.

### ELECTRICAL

- Luminaire is built with the highest quality driver that is Universal Voltage(120V-277V), uses long lasting, highly-efficient LED packages.

### DRIVER

- Driver is fixed on the back of the panel to prevent mis-handling during shipment.

### OPTICAL SYSTEM

- Designed to reduce glare and improve light distribution through precision formed

### DIMMING

Continuous dimming (0-10V) comes standard.

### ENERGY SAVINGS

- Over 50% energy savings than traditionally fluorescent fixtures low heat productions requires less maintenance and operation cost

### LISTING

ETL, DLC, FCC, RoHS

### ENERGY SAVINGS

- 5 Years Limited Warranty, Rated for 50,000 hours (Refer to your warranty documentation for more information.)

## SPECS AT A GLANCE

Configuration	LDT2-S40-3565	LDT4-S50-3565	LDT4-S72-3565
CCT (K)	3500K/4000K/5000K/ 5700K/6500K (Selectable)		
Wattage (W)	15/20/25/30/40W	24/30/35/40/50W	30/40/50/60/72W
Lumens (lm)	1950-5000lm	3250-6500lm	3900-9000lm
Efficacy (LPW)	125-130lm/W		
CRI	≥80		
Input Voltage	120-277V AC		
THD	≤20%		
Certifications	ETL DLC 5.1 Premium		
Dimming	0-10V DC		
Sensor Base	YES		
Lifetime	50,000 hours		

\*Nominal Wattage (Switchable)

## ORDERING INFORMATION



Model	Size	Wattage	Voltage	Lumens	Efficacy	CCT	Dimming	Dimensions
LDT2-S40-3565	2x2	15W, 20W, 25W, 30W, 40W (Selectable)	120-277 V	1950lm, 2600lm, 3250lm, 3750lm, 5000lm	125 - 130 lm/W	3500K, 4000K, 5000K, 5700K, 6500K (Selectable)	0-10 V	23.74"L x 23.74"W x 2.12"H
LDT4-S50-3565	2x4	25W, 30W, 35W, 40W, 50W (Selectable)	120-277 V	3250lm, 3900lm, 4550lm, 5000lm, 6250lm	125 - 130 lm/W	3500K, 4000K, 5000K, 5700K, 6500K (Selectable)	0-10 V	47.72"L x 23.74"W x 2.12"H
LD-T4-S72-3565	2x4	30W, 40W, 50W, 60W, 72W (Selectable)	120-277 V	3900lm, 5000lm, 6250lm, 7500lm, 9000lm	125 - 130 lm/W	3500K, 4000K, 5000K, 5700K, 6500K (Selectable)	0-10 V	47.72"L x 23.74"W x 2.12"H

## MULTIPLE SENSOR SOLUTIONS

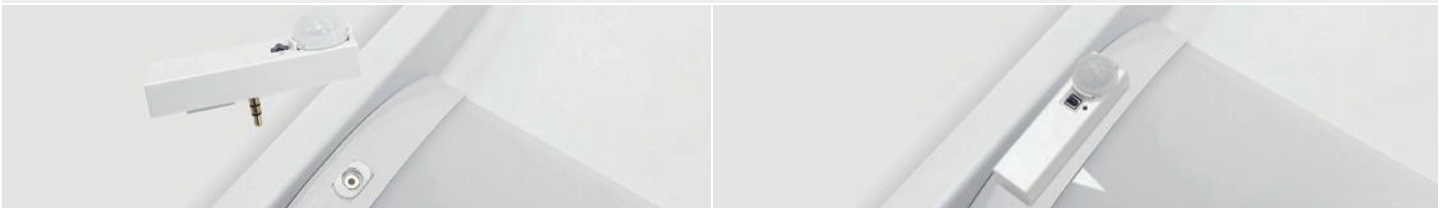
Quick and Easy in-field installation of sensors. (The sensor receptacle is pre-embedded in the profile frame. )



Sensor

Model Number	Sensor Type	Connector	Controller
LDHD08VR-M-1B	Microwave	Audio Jack	Remote Control HD06R
LDHD08VR-MB-1B 	Microwave		HAISEN BLUE APP
LDHD08VR-PB-1B	PIR		Remote Control HD06R
LDHD08VR-PB-1B 	PIR		HAISEN BLUE APP

PHYSICAL SPECIFICATIONS

Unit: mm/ inc h

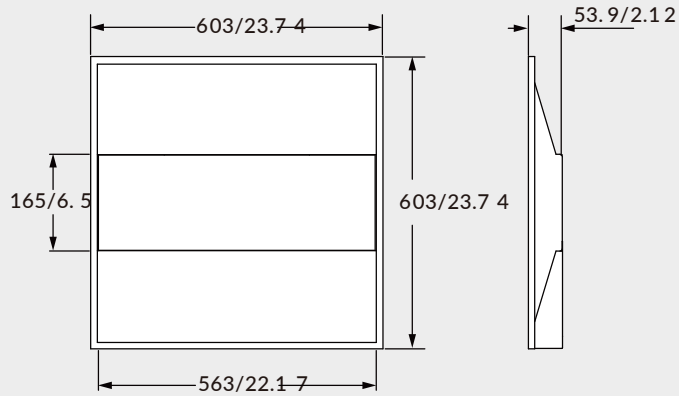

Dimensional tolerances: (+1.5mm, -1.0mm)

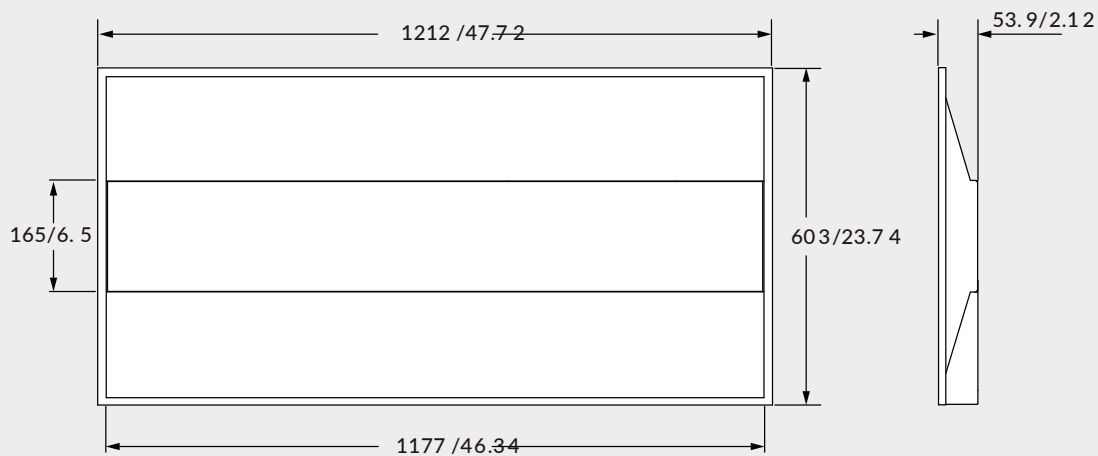

PHOTOMETRIC DATA

2' x 2'

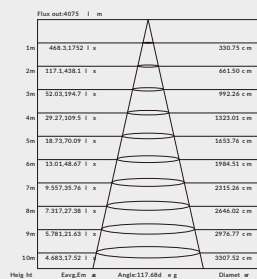
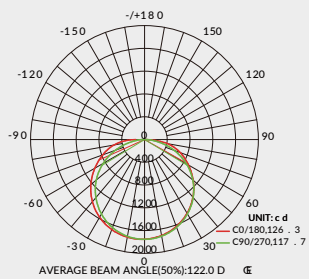

2' x 4'

